



INTERSTATE SALES

TRUSTED SERVICE SINCE 1969

Interstate Sales | 12600 Locksley Lane | Suite 200 | Auburn, California 95602

p: 530.823.6070 | e: info@interstatesales.com | w: www.interstatesales.com



Welcome To The Interstate Sales Catalog

We're pleased to introduce our product lines in this improved format.

Interstate Sales is a family owned and operated business, located in the Northern California Sierra Nevada foothills. Our story began nearly 50 years ago in a rented garage in the San Diego area. Named Interstate Signal back then, the little company's sales grew but the work force remained small, with owner Lee Trentman handling most of the sales, ordering, and delivery duties.

After the Trentman family moved to Auburn, Lee opened Interstate Sales in October, 1969. Early the next year, Lee's mother Lee Vern, moved to Auburn to keep the books, and she faithfully did so until her passing in early 1996.

As the business grew, so did it's work force, and we've been fortunate to have many come and work with us a long time—some over 30 years! Over the years the business has been at 4 different locations-- including a remodeling and enlarging of one location-- and has seen our facility grow from a 300 square foot rented office, to a 30,000 square foot warehouse. Upstairs we have a full service sign shop, ready to fulfill all of your sign, banner, or print needs.

We recognize it is you, our customers, that make our success possible. Our philosophy is that the customer always comes first, and that helping them with their needs will bring them back.

So please take a minute to leaf through our catalog. If you don't see what you need, call us anyway; chances are we can find it for you. We're confident you'll find us amenable, and happy to provide you with quality products at an affordable price.

We don't want all the business, just YOURS!

ADA COMPONENTS	34	OBJECT MARKERS	10
ARROW BOARDS	31	PAINT: marking	40
ASPHALT RAKES	39	traffic Ennis-Flint®	17
BAGS, refuse	24	PAVEMENT MARKERS:	
BARRICADES	26	adhesive	19&20
BARRIERS: pedestrian	14	chip-seal	21
delineation	10&12	non-reflective	
tape	26	plastic	19&21
BATTERIES	27	ceramic	21
BEADS, traffic	18	reflective	20
BRIDGE RAILING	14&15	SOLAR POWERED SIGNS	22
CHANNELIZERS	25	SAFETY FENCE	24
CONES: traffic	25	SHIRTS	29
DELINEATORS: pedestrian	12	SIGN MATERIALS	38
permanent	10&12	SIGN HARDWARE	35thru37
temporary	25	SIGN POSTS	30
CRACK SEAL	23	SMART SEQUENTIAL ROAD FLARE	32
EMERGENCY WARNING BEACONS	29	SIGNS: construction	44
FLAGS	28&29	fabric	28
FLAG STANDS	28	guide	43
FLASHERS	27	regulatory	41
GRACO STRIPERS	45	street name	38
GRACO ACCESSORIES	46	warning	42
HOT MELT APPLICATOR	33	SPEED BUMPS	39
GUARDRAIL	04thru07	STENCILS, pavement	19
GUARDRAIL END TREATMENTS	08&09	STOP/SLOW PADDLES	29
HARD HATS	29	TAPE, highway marking	13
LETTERS, die cut	40	THERMOPLASTIC Ennis-Flint®	16
OMEGA POST	11	THERMOPLASTIC PREFORMED Ennis-Flint®	13
PAVEMENT MARKINGS Ennis-Flint®	13	THRIE-BEAM BARRIER	07
POT HOLE PATCH	23	TRAFFIC BEADS	18
		VESTS	29
		WHEEL STOPS	39
		WHEEL STOPS	24

CONDITIONS OF SALE

SHIPPING SCHEDULES: Seller cannot be responsible for shipping delays over which he has no control.

FREIGHT: All items are quoted and sold F.O.B. Auburn, CA., with transportation charges prepaid and added for government accounts.

TAX: Add all applicable taxes to quoted prices.

TERMS: Net 30 days on approved credit. One and one half percent (1-1/2%) interest per month, or portion thereof, will be charged on past due accounts. Customer acknowledges liability for court costs, including attorney's fees, resulting from collection expenses, unless prior mutual agreement is made in writing.

BACKCHARGES: Customer acknowledges that vendor will not accept any backcharge unless prior mutual agreement is made in writing, and vendor issues a credit memo confirming subject agreement.

SPECIAL HANDLING: Federal Express, and U.P.S. air and ground services are available at customer expense.

RETURNED MERCHANDISE: Material returned for the customer's convenience is subject to the seller's acceptance, and a 15% restocking charge. Material must be in new condition, and returned freight prepaid subsequent to the seller's authorization.

SELLER'S LIABILITY: Seller makes no representation or warranty, neither expressed nor implied, of any kind as to the suitability for a specific purpose or any other matter with respect to the products illustrated herein. The seller shall not be liable for any loss, damage, or injury whether direct or consequential arising as a result of using these products. The seller's sole responsibility and obligation shall be to replace such quantities of seller's product that is proven to be defective. No claim shall exceed the cost of the product found to be defective.



INTERSTATE SALES



**MIDWEST GUARDRAIL SYSTEM
(MGS) W-BEAM**

**12" W-BEAM
RAIL HEIGHT: 31"
RAIL SPLICE:
MID-SPAN BETWEEN POSTS**

WB 31" TRANSITION



**MGS 31 SPECIFICATIONS
PEDESTRIAN BARRIERS
BRIDGE CONNECTONS BURIED
POST ANCHORS CABLE END
ANCHORS TYPE A and B END
CAPS RADIUSED RAIL
MASH END TERMNAL SYSTEMS**

**RETURN SECTIONS
STEEL POSTS
TERMINAL SECTIONS
TRANSITION SECTIONS
THRIE-BEAM BARRIER
WOOD POSTS
WB TRANSITIONS
HOT-DIPPED GALVANIZED FINISH**



INTERSTATE SALES

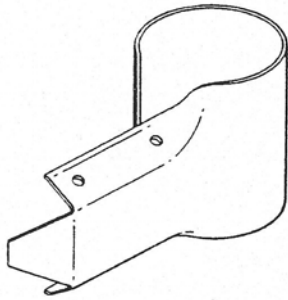

**2022 CA STD END CAP
TYPE B 3/4 WRAP**

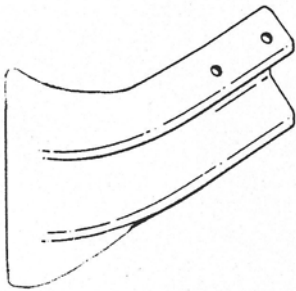
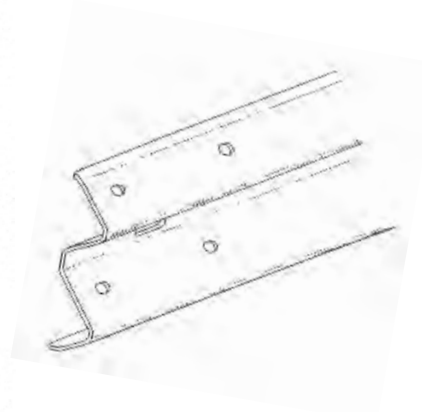

END CAP FISH TAIL

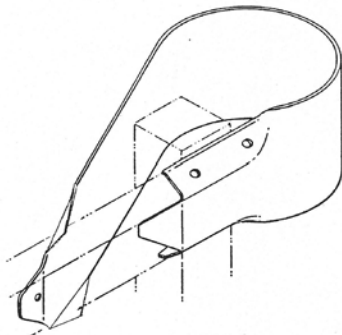

END CAP TYPE C

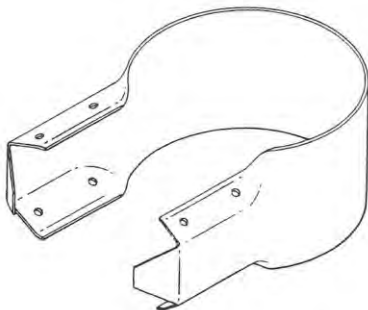

RETURN CAP TYPE A



PLASTIC MONDO BLOCKS

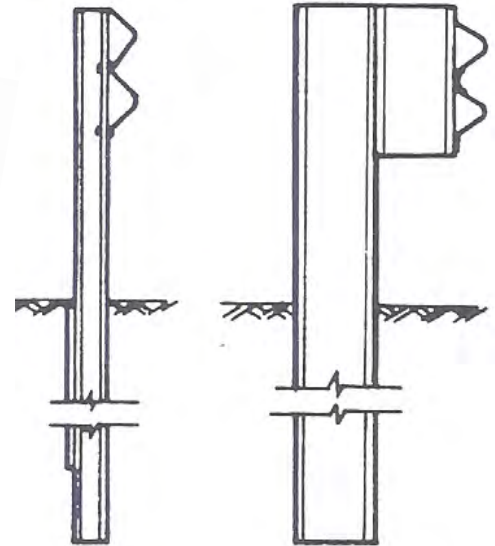
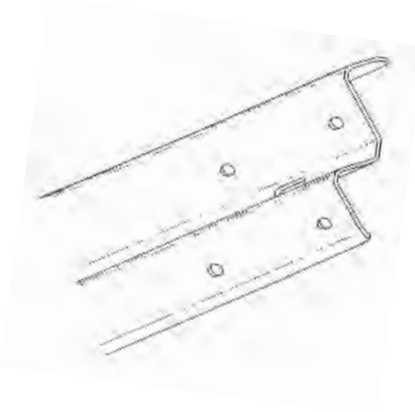

STEEL POSTS and BLOCKS

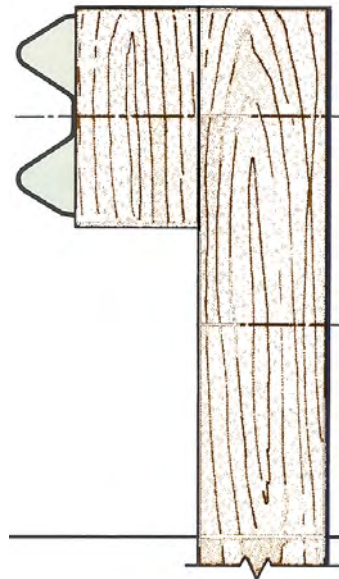

WOOD POSTS and BLOCKS



INTERSTATE SALES

Functions of 12'-6" arc for different radii

Radii	Angle	Chord	Height (rise)
5	143° 14'	9'-5 7/8"	3'-5"
10	71° 37'	11'-8 3/8"	1'-10 3/4"
15	47° 45'	12'-1 3/4"	1'-3 3/8"
20	35° 49'	12'-3 5/8"	11 5/8"
25	28° 39'	12'-4 1/2"	9 3/8"
30	23° 52'	12'-4 7/8"	7 3/4"
35	20° 28'	12'-5 1/8"	6 5/8"
40	17° 53'	12'-5 3/8"	5 7/8"
45	15° 55'	12'-5 1/2"	5 1/4"
50	14° 19'	12'-5 5/8"	4 5/8"
55	13° 01'	12'-5 5/8"	4 1/4"
60	11° 56'	12'-5 3/4"	3 7/8"
65	11° 01'	12'-5 3/4"	3 5/8"
70	10° 14'	12'-5 3/4"	3 3/8"
75	9° 33'	12'-5 3/4"	3 1/8"
80	8° 57'	12'-5 7/8"	3"
85	8° 26'	12'-5 7/8"	2 3/4"
90	7° 58'	12'-5 7/8"	2 5/8"
95	7° 32'	12'-5 7/8"	2 1/2"

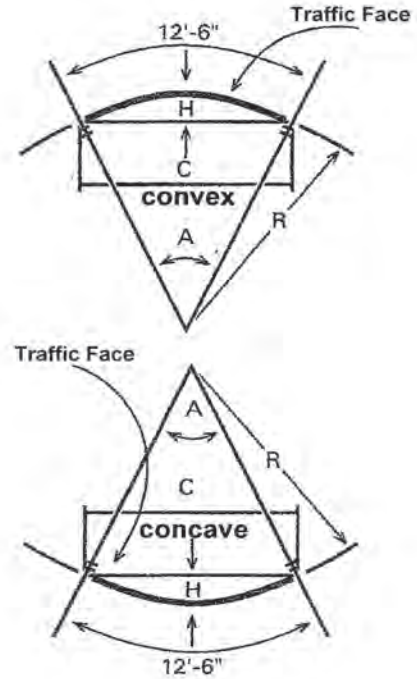

TO ORDER

- 1-Stretch a line from outside post bolt hole to outside post bolt hole. (C)
- 2-Measure the distance from the rail face to the line. (H)
- 3-Your order should include the (H) measurement, and the convex or concave shape to the rail section.



INTERSTATE SALES

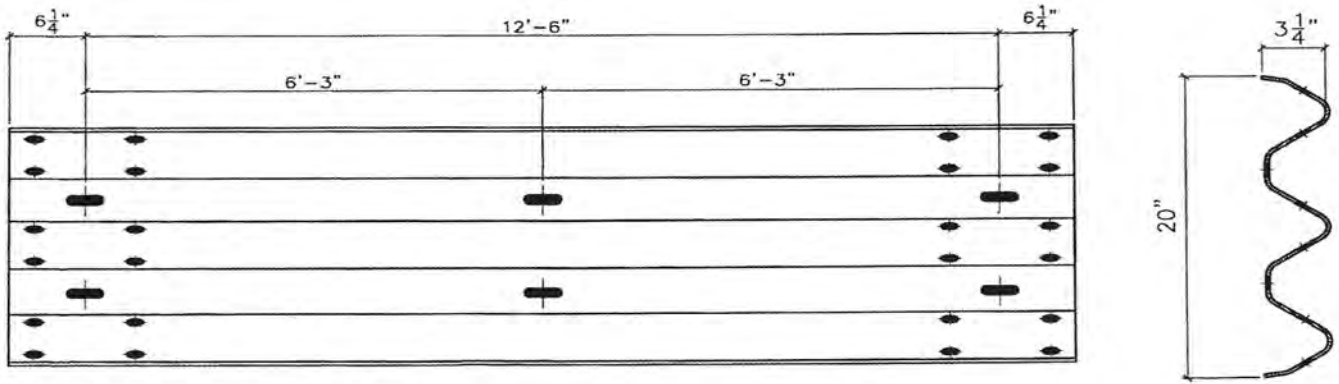

THRIE BEAM BARRIER
 Stocked in 12'6" and 6'3" Sections - Hot-Dipped Galvanized
 Hole Punching For Post Spacing at 3'1-1/2" and 6'3" OC

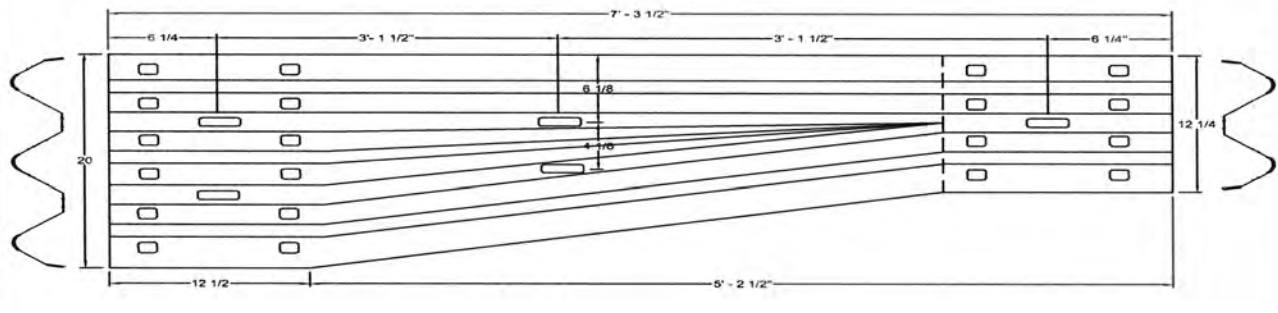

THRIE BEAM TRANSITION SECTION

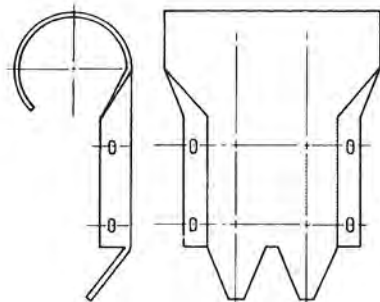

END CAP TYPE TB 3/4 WRAP

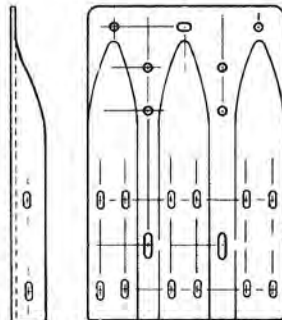

END CAP TYPE TC

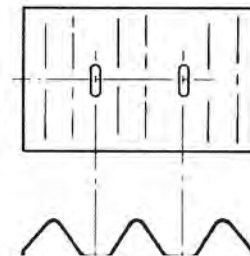

BACK-UP PLATE

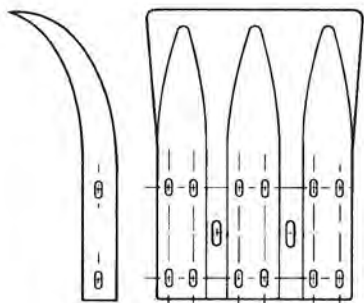

END CAP TYPE TC FISH TAIL

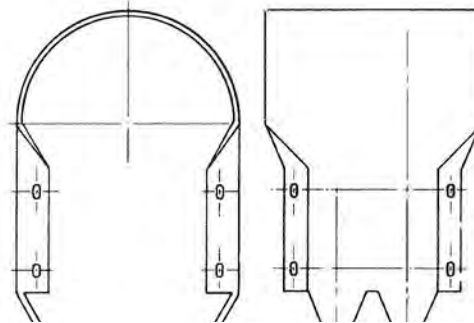

RETURN CAP TYPE TA



INTERSTATE SALES

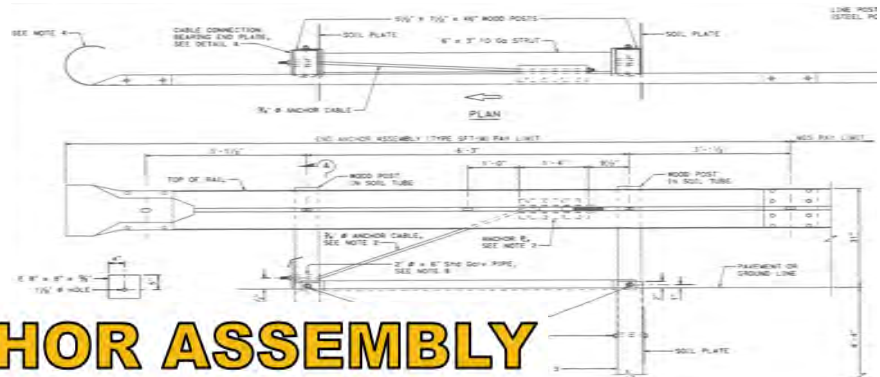
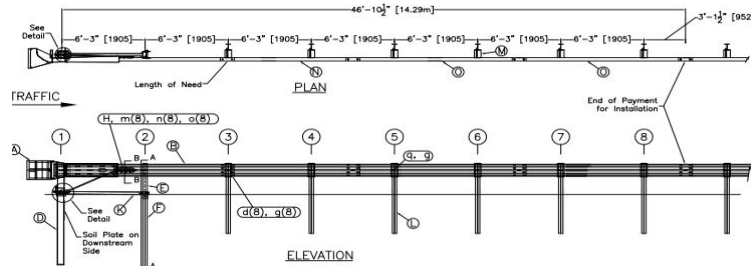

SFT-M ANCHOR ASSEMBLY

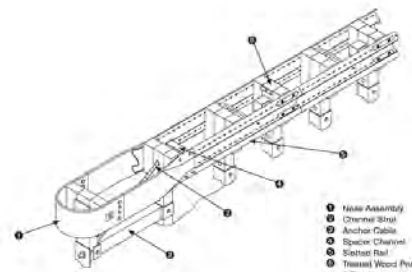

CAT® 350



INTERSTATE SALES

REACT M™

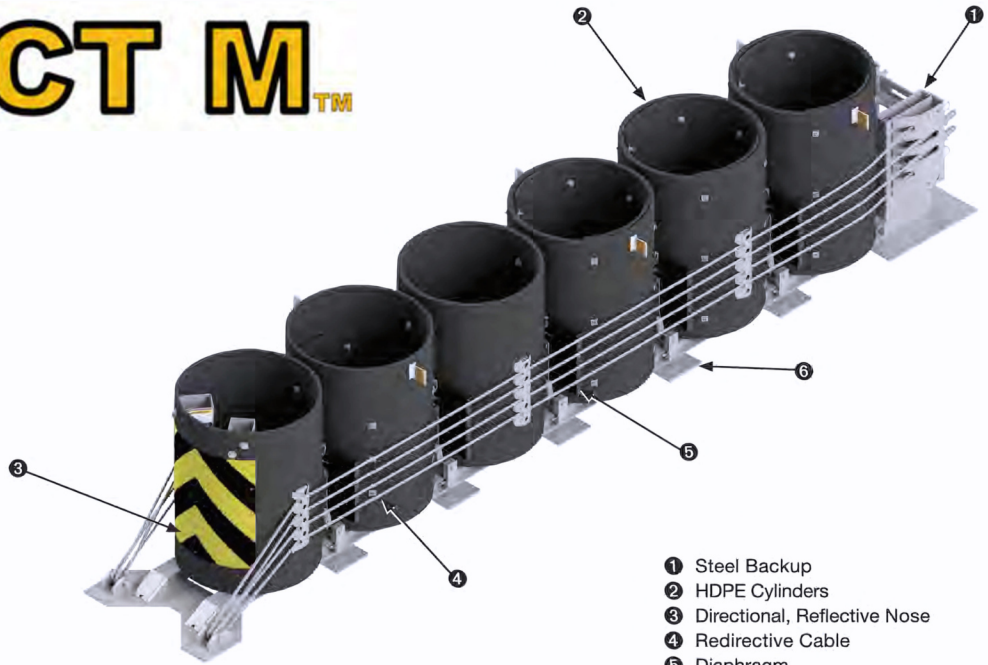

- 1 Steel Backup
- 2 HDPE Cylinders
- 3 Directional, Reflective Nose
- 4 Redirective Cable
- 5 Diaphragm
- 6 Simple Anchorage



Soft Stop®



INTERSTATE SALES



CHANNELIZER



left right

TYPE P



CLASS 1



CLASS 2

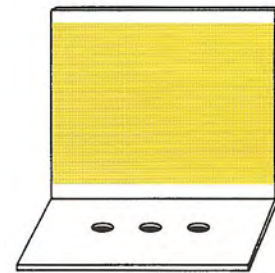
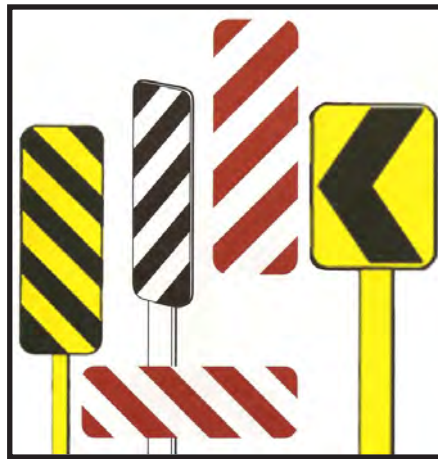

BARRIER
DELINEATOR

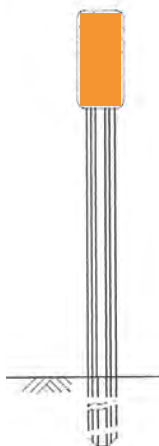

TYPE L-2

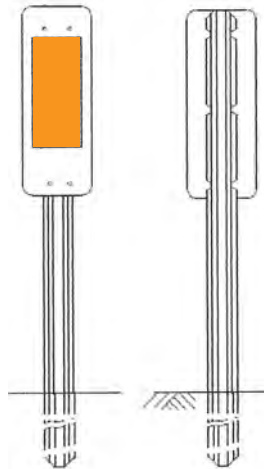

TYPE L-1

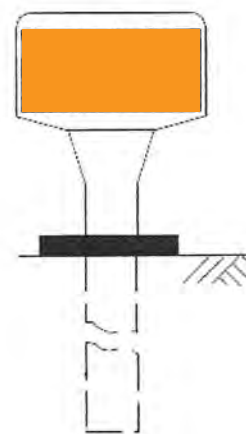

TYPE K-1



INTERSTATE SALES

ΩmegaPost

IMPACT recovery
SYSTEMS™



**NTPEP
TESTED
200+
IMPACTS
AT 70
MPH**

BEST HIGH SPEED MANAGED LANE SOLUTION

- No fasteners to corrode
- Simple installation and replacement
- Durable, high speed performance
 - Heavy load crash tolerant
- Type V Super high intensity sheeting
- Ultraviolet light, ozone, and hydrocarbon resistant
 - 100% made in the USA
 - MUTCD compliant
- Category 1 Self Certified Device
 - Patent Pending



INTERSTATE SALES

IMPACT recovery SYSTEMS™

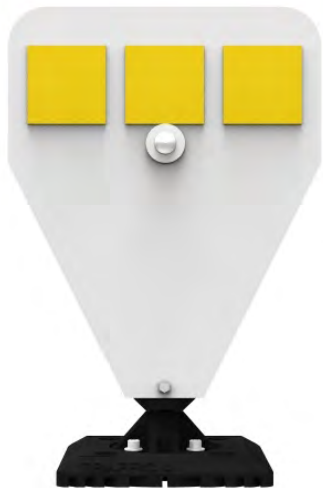

K Marker



Pedestrian Crossing Marker



Multipurpose Post



Curb Systems



INTERSTATE SALES

Ennis-Flint® by PPG
PreMark®

Preformed Thermoplastic



Pavement markings

Engineered to provide performance, lasting value and extended life to your pavement marking program

Pre-cut ENNIS-FLINT® by PPG PREMARK® pavement markings are formulated with high-quality resin, binder and aggregate for year-round application in any temperature.

Depending upon regulatory requirements or specific application purposes, *PreMark* pavement markings can be manufactured with visibility boosting retroreflective beads and/or safety enhancing anti-skid elements.



Installation

ENNIS-FLINT® BY PPG PREMARK® materials can be applied with an industrial propane heat torch. Regularly spaced indents in the material indicate when the required molten state, satisfactory adhesion and proper bead embedment have been achieved. A recommended sealer is required when applying *PreMark* material on concrete surfaces and for large, multi-colored specialty markings and colorized lanes.

Need ideas? Your PPG sales representative can provide no-cost demo and application training for proper application techniques.



Step 1: Prepare



Step 2: Position



Step 3: Heat



INTERSTATE SALES



Installing CALTRANS B11-51

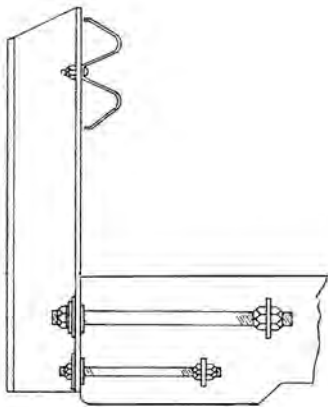

Metal Beam Rail

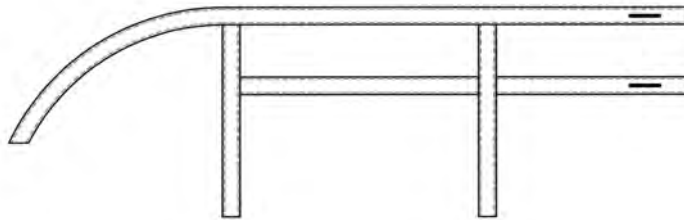

B11-51 Tube Rail Elevation

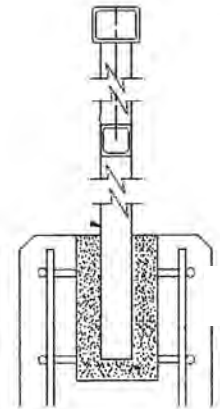

B11-51 Cross Section



Pedestrian Barriers



INTERSTATE SALES



Typical Metal Tube Bridge Railing

CURRENT METAL TUBE BRIDGE RAILING SYSTEMS

ST10

ST20S

ST30

ST40

ST70



CALTRANS ST - 30 Bridge Rail



INTERSTATE SALES

Ennis-Flint® by PPG Thermoplastic

Thermoplastic

For streets, highways,
local, rural roads and
parking lots



A full line of durable thermoplastic products

ENNIS-FLINT® by PPG Thermoplastic pavement markings are a 100% solid, user safe compound containing pigments, glass beads, binder and filler which becomes liquid when heated. This formulation provides toughness, flexibility and bond strength while holding components together.

Intermixed and drop-on glass beads provide retroreflectivity for nighttime visibility of the pavement marking.



**Available in
Alkyd, Hydrocarbon, and Thermodrop™**



INTERSTATE SALES

Ennis-Flint® by PPG
Traffic Paint

Waterborne and Solvent Based



For streets, highways,
local, rural roads and
parking lots

A broad portfolio of traffic paint products

ENNIS-FLINT® by PPG TRAFFIC PAINT pavement markings offer a full line of traffic paints in both waterborne and solvent based formulations.

From highway striping to parking lot delineation, choose from our versatile selection of traffic paints for your next pavement marking project.



All Specifications available



INTERSTATE SALES



TRAFFIC BEADS

MAKING ROADS AND AIRPORTS SAFER

CALTRANS TYPE I	non-moisture proof
CALTRANS TYPE II	moisture proof
AASHTO, M247, TYPE II	"Double Drop"
AASHTO, M247, TYPE I	non-moisture proof
AASHTO, M247, TYPE II	moisture proof

TTP 1325B, GRADATION A, TYPE III, HIGH INDEX, AIRPORT BEAD
TTP 1325C, GRADATION A, TYPE III, HIGH INDEX, MILITARY BEAD
TTP 1325, GRADATION A or B, TYPE IV

*Notes: 1) 500 lb. drums, and 2,000 lb. totes available
2) Other State and Federal Specifications available



INTERSTATE SALES

PAVEMENT STENCILS

ALUMINUM or PLASTIC

STANDARD AND CUSTOM

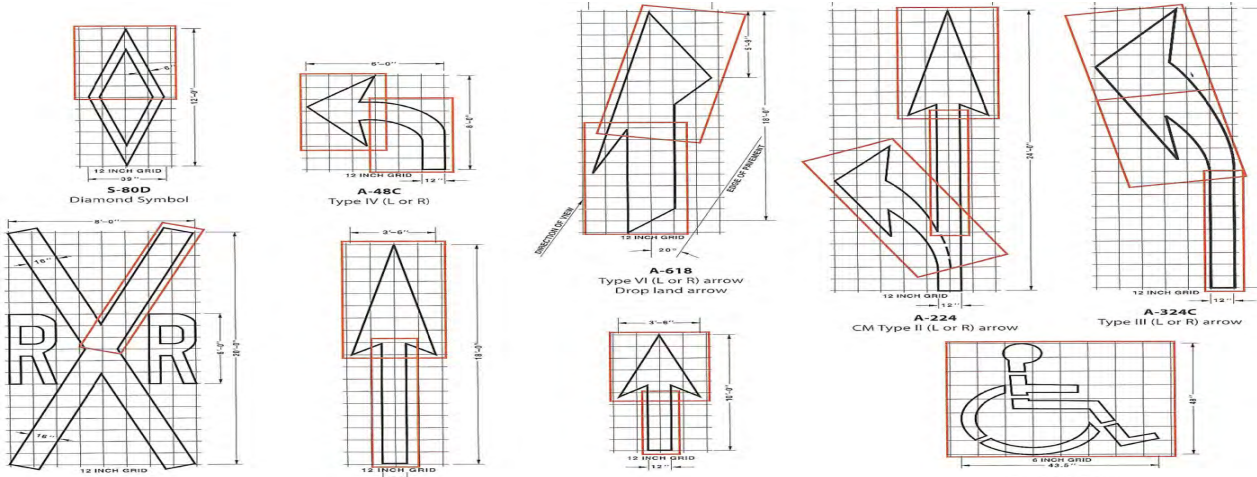

TWO PART EPOXY



Two Part Epoxy Adhesives

- Rapid Set, 1 Gallon, Part A
- Rapid Set, 1 Gallon, Part B
- Std. Set, 1 Gallon, Part A
- Std. Set, 1 Gallon, Part B

- Rapid Set, 20 oz. Kit
- 10 oz. Part A
- 10 oz. Part B

PLASTIC MARKERS



Plastic Pavement Markers

- Lime Green - School Areas
- Black - Fog & Limited Visibility Areas
- White - Skip Lines and Edge Lines
- Yellow - Center Lines



INTERSTATE SALES

RAISED REFLECTIVE PAVEMENT MARKERS

STIMSONITE®



Model C80 & C40

High impact resistant polymer base and lens

APEX®



Model 828/828 AR Glass Face

Durable ABS plastic shell filled with an inert thermosetting compound



Proven Performance
High Reliability
Superior Adhesion
Superior Cohesion

Standard Bituminous Adhesive
Available In Four 13.75#
Segments Per 55 Pound Box
Palletized 36 Boxes Per Pallet

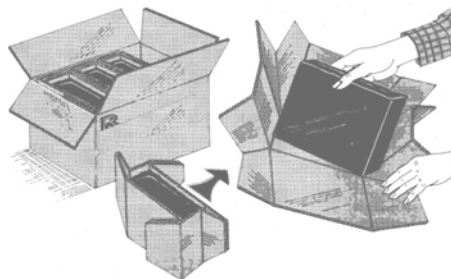

Meets State and Fed. Specs
Impact Resistant
Consistant Quality
Rapid Setting

Flexible Bituminous Adhesive
Available In Four 11.00#
Segments Per 44 Pound Box



INTERSTATE SALES

NON-REFLECTIVE AND CHIP SEAL PAVEMENT MARKERS

Polypropylene Plastic Markers



Type A (white)

Type AY (yellow)

“made in california from recycled polypropylene plastic”

packaged 50 pieces per carton shipping weight 7 pounds

CERAMICS



Type AY (yellow)

Type A(white)

packaged 50 pieces per carton shipping weight 30 pounds

CHIP SEALS

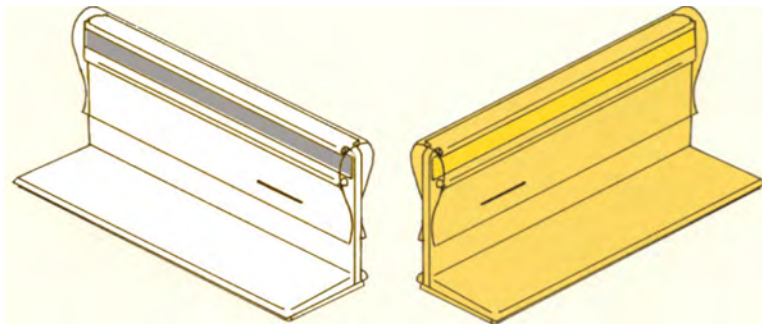

Packaged 500 pieces per carton shipping weight 27 pounds



INTERSTATE SALES



Solar Powered Traffic Control Solutions



Solar Powered Flashing Beacon

Available in Red or Amber
MUTCD Compliant
Multiple Activations Available



Solar Powered Rapid Flashing Beacon

Upgrade Crosswalks
Multiple Activations Available



INTERSTATE SALES

POT HOLE PATCH

Easy to Use 50 lb.bag

Superior Workability

Excellent Compaction

Municipality Grade 310

Application Instructions



SAFETY.
Use temporary warning signs.



CLEAN SURFACE.
Remove dust and debris with shovel or broom



POUR POT HOLE PATCH.
Overlap edges by 1" (2.5 cm); for potholes deeper than 2" (5 cm), apply in layers. Do not pour over clay, ice or mud. Dispose of bags properly.



COMPACT.
Use tamper, shovel, vibrating plate or wheel of a truck. Repair area should rise +/- 1/2" (13 mm) above road bed.

Henry
#1 CHOICE OF PROFESSIONALS

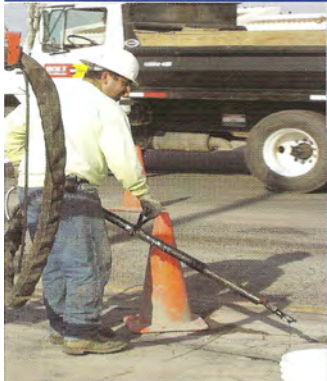

Detector Loop Sealants

CRACK SEAL

Duroflex Detector Loop Sealant

HE760 Hot Pour Asphalt Sealant

CAL SEAL CRACK SEALER is mixture of paving asphalt, ground rubber, and polymer which conforms to all CALTRANS specifications for hot melt material.

DUROFLEX ASPHALT CRACK AND JOINT SEALER is a premium hot melt polymer-modified, asphalt crack sealant designed for use on asphalt and concrete surfaces.



HENRY HOT MELT TRAFFIC SAFETY PRODUCTS

DURABILITY & ECONOMY



INTERSTATE SALES

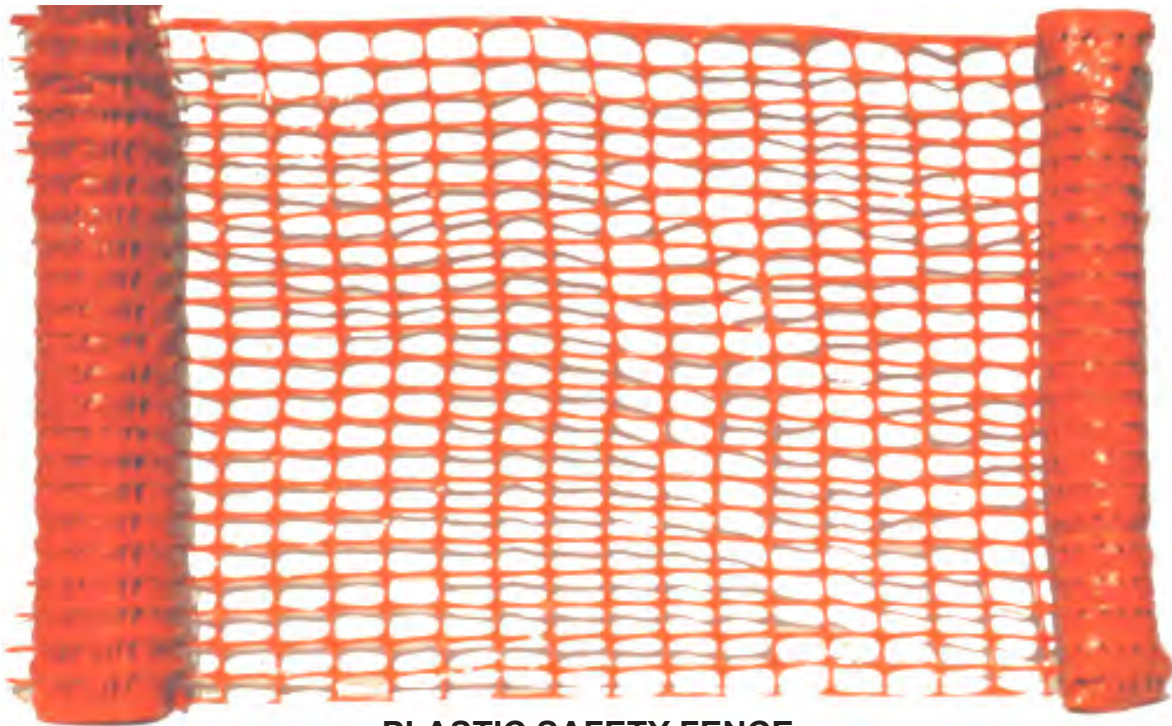

**PLASTIC SAFETY FENCE
HI-DENSITY - LIGHT WEIGHT - ORANGE
STOCKED IN 4' X 100' ROLLS**



ROADSIDE REFUSE BAGS

**HIGH VISIBILITY ORANGE
DIMENSIONS:
33"X40"X4 mil.
packaged 100 bags per case**

E-Z REACHER PICK-UP TOOL

**LIGHT AND EASY OPERATING
IDEAL FOR HIGHWAY AND
GROUNDS MAINTENANCE
REPLACEMENT CUPS IN STOCK**



INTERSTATE SALES



**TRAFFIC CONES, AVAILABLE IN ORANGE OR GREEN WITH REFLECTIVE COLLARS
HEIGHT (WEIGHT) CHOICES 36"(10#) 28"(10#) 28"(7#) 18"(5#) 18"(3#) 12"(1.5#)**



CHANNELIZER DRUMS

PORTABLE DELINEATORS W/3" REFLECTIVE BANDS, 42" HEIGHT WITH 12# BASE



INTERSTATE SALES



Type III Barricade



Barricade Tape



Plastic Parade Barricade



Reflective Sheeting



Big Sandy
Impact Attenuator San Barrels



Type I and II
Plastic
Barricade



Caution Tape

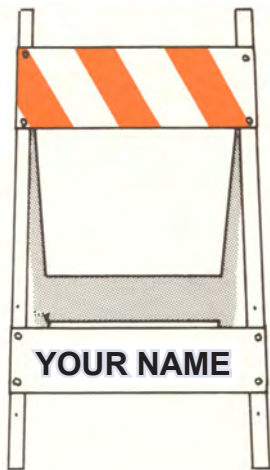

Type I Wood and Metal



Plastic Channelizer

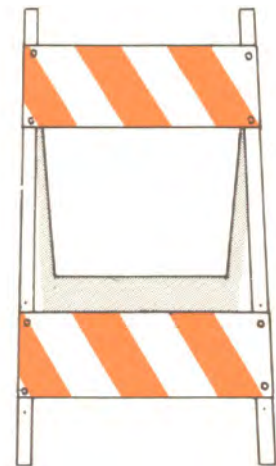

Type II Wood and Metal
Barricade



INTERSTATE SALES



Hi-Intensity-Solar Powered-Dual Function LED-Flashing or Steady Burn-Hazard Light



Traffic Wand-C Cell Powered-Flashing or Steady Burn-LED Illumination Light



LED Light Source-D Cell Powered Hazard Light-Flashing or Steady Burn



Flashing or Steady Burn-Flasher Light-Incandescent-6Volt Battery Powered



D Cell Batteries



6 Volt, Spring Terminal Lantern Batteries



INTERSTATE SALES



Roll-Up Signs



Flag Stands



Quickstands



Crash Barrels



INTERSTATE SALES



SPC-28 w/12" Handle



C-28 w/5' Staff



Safety Vests and Shirts
Class 1, 2, and 3 Vests In Stock
Class 2 Vests Illustrated



Flagger Flags



Hard Hats



EMERGENCY VEHICLE
STROBE BEACON



INTERSTATE SALES



SQUARE TUBE POST
GALVANIZED OR PAINTED FINISH
STANDARD SIZES AND COMPONENTS



POST DRIVER



CHANNEL "U" POST
HOT-DIPPED GALVANIZED OR
PAINTED FINISH-STOCKED IN
11 GAGE-STANDARD LENGTHS



GALVANIZED ROUND TUBE POST
2-3/8" OD X VARIABLE LENGTHS
LIGHT OR HEAVY WALL THICKNESS



DELINEATOR
POSTS
11 OR 13 GAGE



CHANNEL "U" SNO-POLES
11 GAGE - PAINTED - VARIABLE
LENGTHS

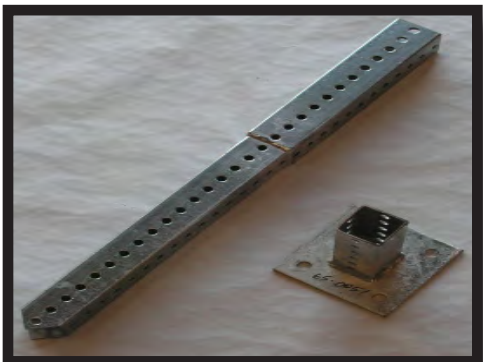

Square Post Base Accessories

FHWA APPROVED INSTALLATIONS FOR SQUARE POSTS



DIRECT INSTALLATION

The Ulti-Mate sign post can be installed directly into the ground using power equipment or a sledgehammer with driving cap.



EZ INSTALLATION

The Ulti-Mate 12 gage anchor system allows crews to work at ground level for fast installations and replacements. The Ulti-Mate anchor is installed directly into the ground, leaving 1 or 2 holes above grade level. The Ulti-Mate sign post slides into the anchor for safe and easy installations.



HI-IMPACT INSTALLATION

The Ulti-Mate double 12 gage system is for areas that require frequent replacements due to damaged sign posts. This unique method utilizes a two-piece breakaway anchor that makes replacement work fast and safe.



INTERSTATE SALES

ARROW BOARDS



MESSAGE BOARDS



INTERSTATE SALES

pi·lit Our mission is simple:
to get you home safe at night



Second Generation Sequential Flare

Our second generation smart flare incorporates 5 years of experience and input from thousands of users worldwide.

We're here to *guide* drivers, not just warn them. They're already warned when they come upon a scene but where are they to go?

Key Features

- › **Sequential Flashing Patterns**
Advanced warning through guidance
- › **Tilt Sensor** automatically selects best light source
- › **Rapid Deployment System**
automatically turns on/syncs flare
- › **Make cones an active warning**
Brightly illuminates a traffic cone
- › **Crush Proof** (Independent lab 50,000 lbs. crush strength)
- › **IP67 Rating**
- › **Cost Effective;** Short Return on Investment (ROI)
- › **Reverse flash direction**
Deploy in the reverse order
- › **Individual flare weight**
0.56 lbs (9 oz)



Use phone camera to scan and view videos on YouTube.

Built, designed, supported in the U.S.A.



INTERSTATE SALES



Left side view

MODEL 1001 HOT MELT APPLICATOR

Used to apply pavement and channel markers using bitumen adhesives



Right side view



INTERSTATE SALES

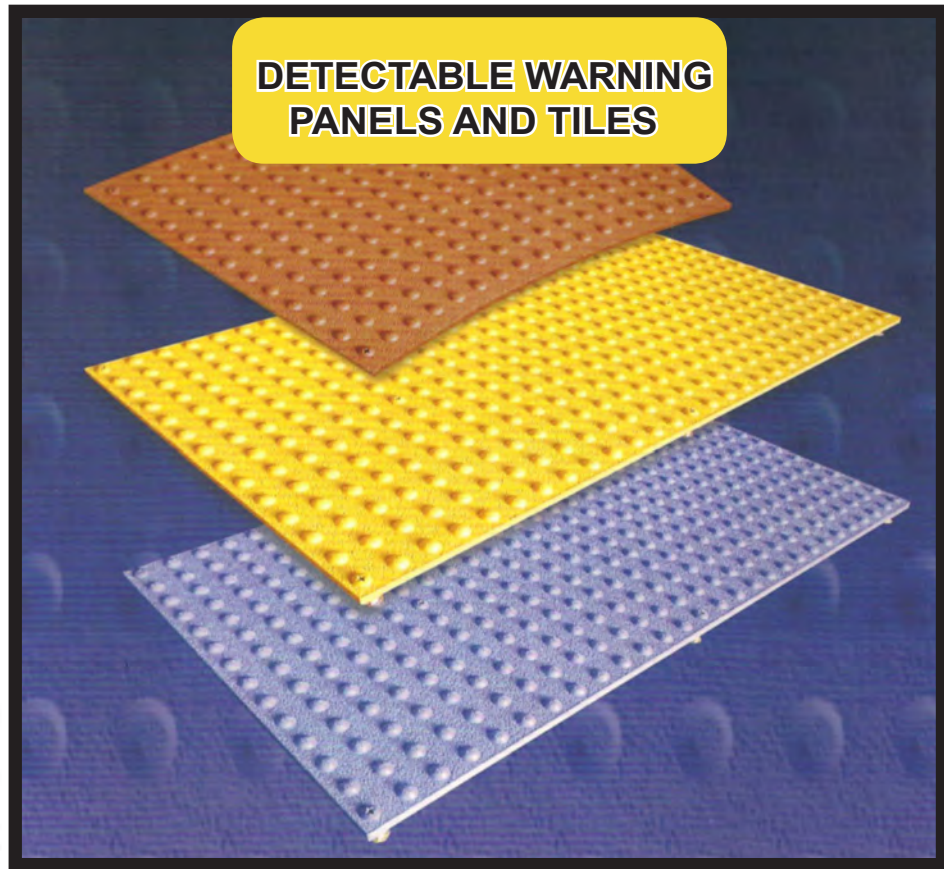
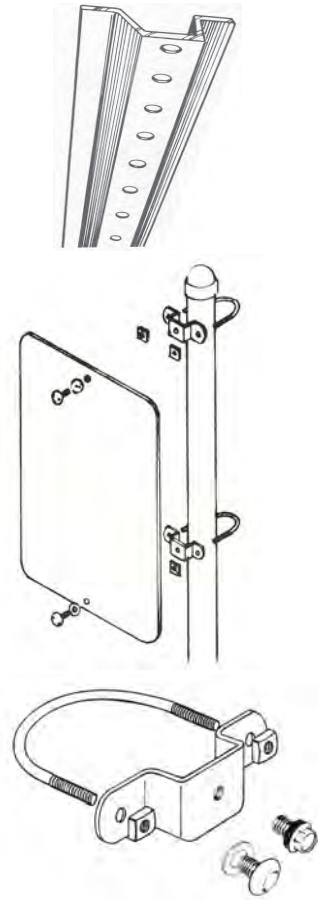

Wet Set w/Hardware and Glue Down w/Adhesive Panels
 3'x4' panels in stock for your convenience

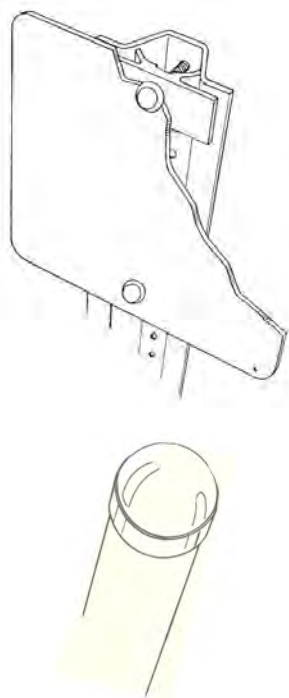

TYPICAL VEHICLE AND PEDESTRIAN CONTROL SIGNS TO COMPLY WITH THE AID TO DISABLED AMERICANS REQUIREMENTS



INTERSTATE SALES

SIGN MOUNTING BRACKETS

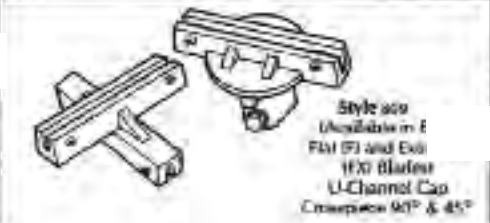
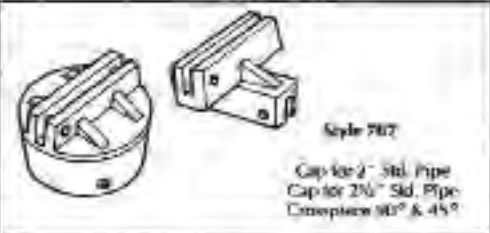
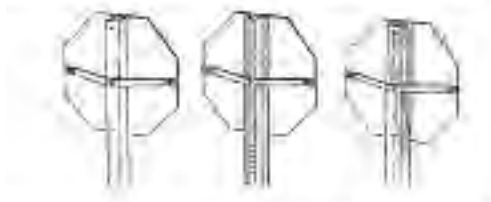
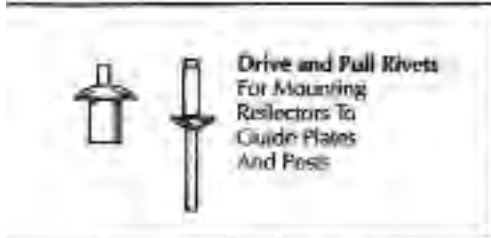

INTERSTATE SALES



Style 744
Cantilever for Wood,
Pipe and U-Channel Posts
Bolt-thru only



Style 28-A
Cap for 2" Std. Pipe
Crosspiece 90°
For Ex Blade Only

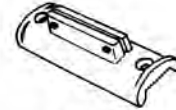

Style 731F
Side Mount For Wood,
Pipe & 4-Channel Posts

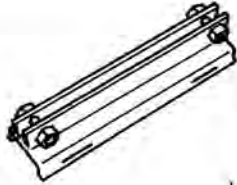

Style 730
Cantilever For
Extruded Blades
For 6" Blades
For 6 1/4" Blades
For 9" Blades
Hex Cap Screws & Nuts

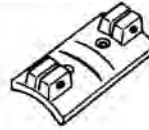

Style 721
Wing Bracket
For Flat Blades Only



Style 702
For 2" Std. Pipe

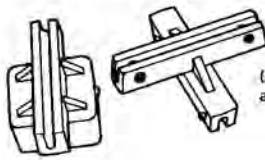

Style 850 Long
(Available for both Flat (F)
and Extruded (EX) Blades)
Cap for 1 1/2" Sq. Tube
Cap for 1 3/4" Sq. Tube
Cap for 2" Sq. Tube
Crosspiece 90°
Slot 5 1/4" Long



Style 1010
Cantilever Arm Support
Standard Drilling or
Special Bolt-thru Drilling



Style 1111F
1. Spot Face Drilling
2. Counter Bore Drilling
3. Counter Sink Drilling
Nos. 1, 2, & 3 with or
without rib bottom



Style KC 250
Cantilever Arm
Bracket



Style KC 500
Cantilever Arm
Bracket

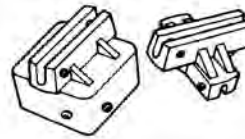

Style 850 Short
(Available for both Flat (F)
and Extruded (EX) Blades)
Cap for 1 1/2" Sq. Tube
Cap for 1 3/4" Sq. Tube
Cap for 2" Sq. Tube
Crosspiece 90°
Slot 3 1/4" Long



Style 406
For 6" Blades & 2" Std. Pipe 4-Way
For 4" Blades & 2" Std. Pipe 4-Way
For 6" Blades & 2" Std. Pipe 2-Way

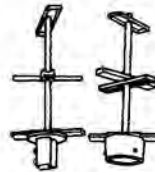

Style 556
Cap for 2" Std. Pipe
Cap for 2 1/2" Std. Pipe
Separators
Center Rod
Dome Nut
Four Way Complete
Two Way Complete
Specify Center Hole Taped or Untaped

Style 556-UC

Cap for U-Channel Post
Four Way Complete

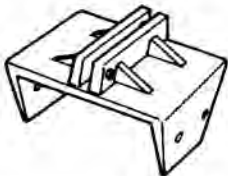

Style 827
(Available for both
Flat (F) and Extruded
(EX) Blades
Cap for 4x4 Wood Post

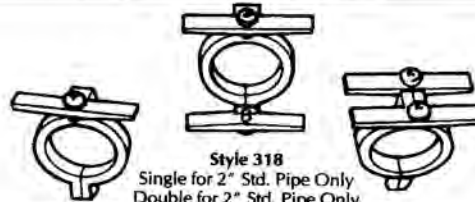

Style 318
Single for 2" Std. Pipe Only
Double for 2" Std. Pipe Only

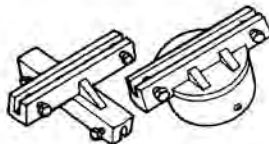

Style 808 Bolt-Thru
(Available in Both
Flat (F) and Extruded
(EX) Blades
Cap for 2" Std. Pipe
Cap for 2 1/2" Std. Pipe
Crosspiece 90° & 45°

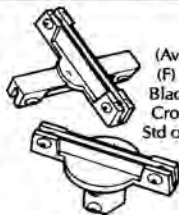

Style 909
(Available in both flat (F)
and Extruded (EX) Blades)
U-Channel Cap
Crosspiece 90° & 45°
Std or Vandal proof bolts



Style 909 Bolt-Thru
(Available in both flat (F)
and Extruded (EX) Blades)
Cap for 2" Std. Pipe
Cap for 2 1/2" Std. Pipe
Crosspiece 90° & 45°
Customized Machined for
Bolt-thru Application to
prevent vandalism



INTERSTATE SALES

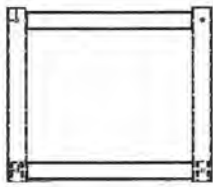

GALVANIZED STEEL ROUTE MARKER FRAME



EXTENSION BRACKET

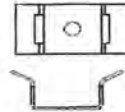

STAINLESS STEEL SADDLE BRACKET

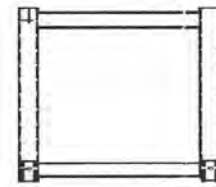
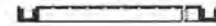

ALUMINUM ROUTE MARKER FRAME

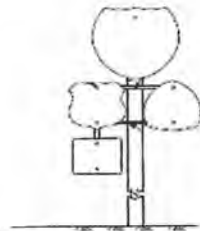

MULTIPLE SIGN INSTALLATION FRAME AND EXTENSION ARMS

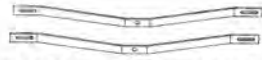

GALVANIZED STEEL BACK BRACE



SINGLE SIGN INSTALLATION



DOUBLE SIGN INSTALLATION

ELECTROLIER INSTALLATION ON SIGNAL STANDARD OR ON SIGN STRUCTURE

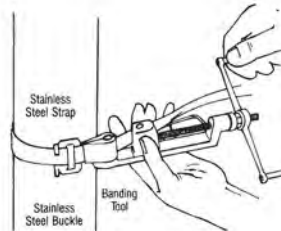
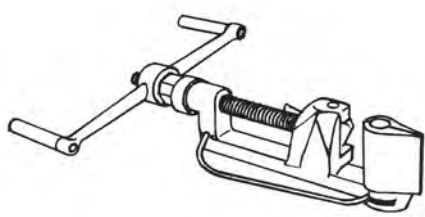

BAND AND BUCKLE SIGN INSTALLATION SYSTEM COMPONENTS



Use the **CABLE TIE SYSTEM** for simple, rapid installation. This system requires a minimum parts inventory, and does not require specialized installation tools.

STAINLESS STEEL CABLE TIE INSTALLATION SYSTEM COMPONENTS



INTERSTATE SALES

SIGN BLANKS, SHEETING, & VINYL

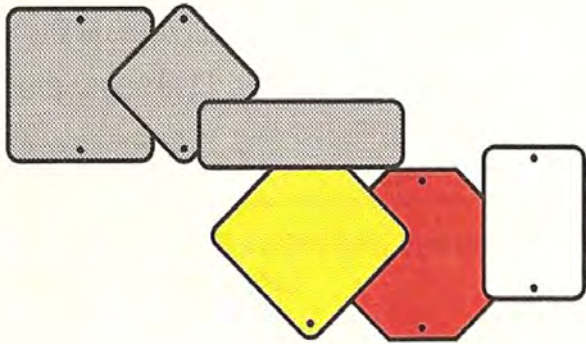

Please call for quotations on your sign material needs, and when ordering, specify punching, sheeting and corner radius requirements.

SIGN SHOP



SIGNSHOP@INTERSTATESALES.COM



INTERSTATE SALES

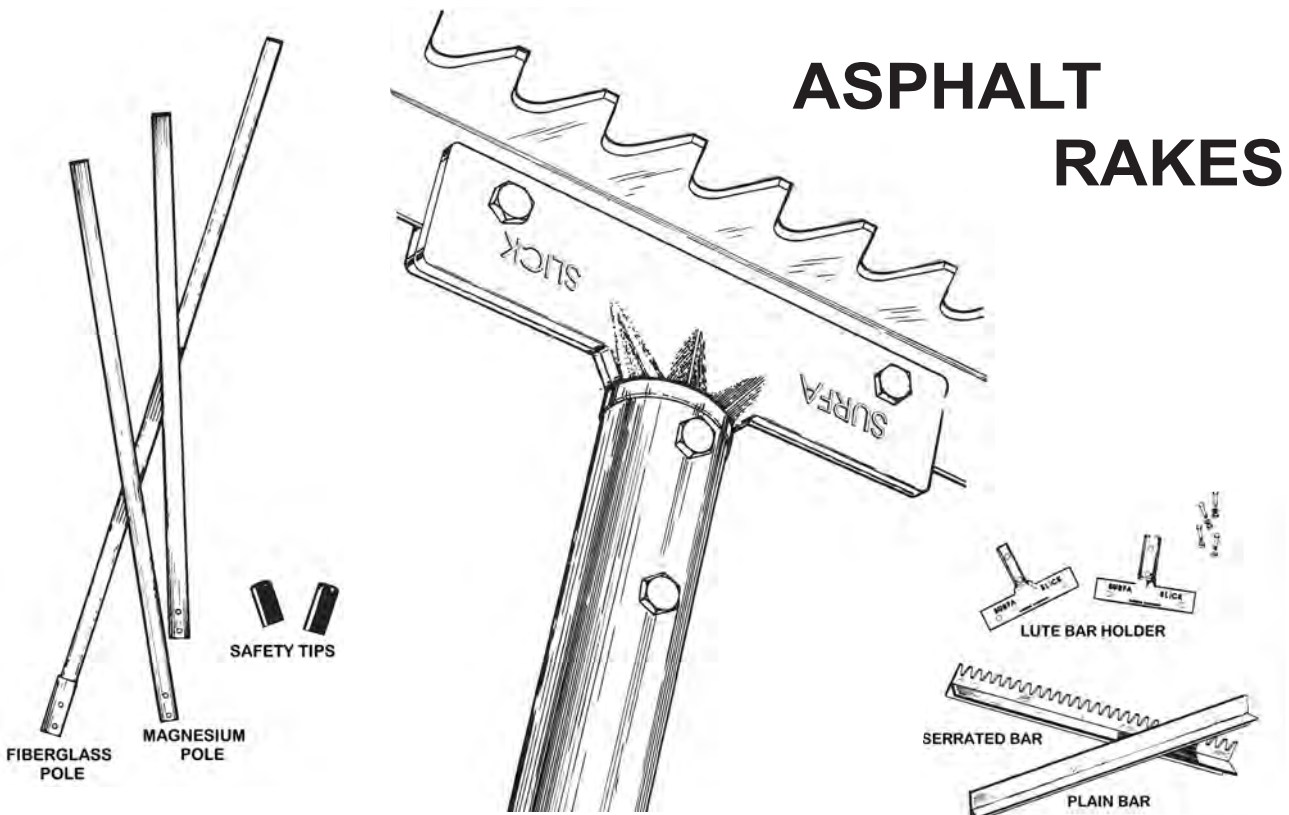

Car Stops - Speed Humps - Speed Bumps



INTERSTATE SALES

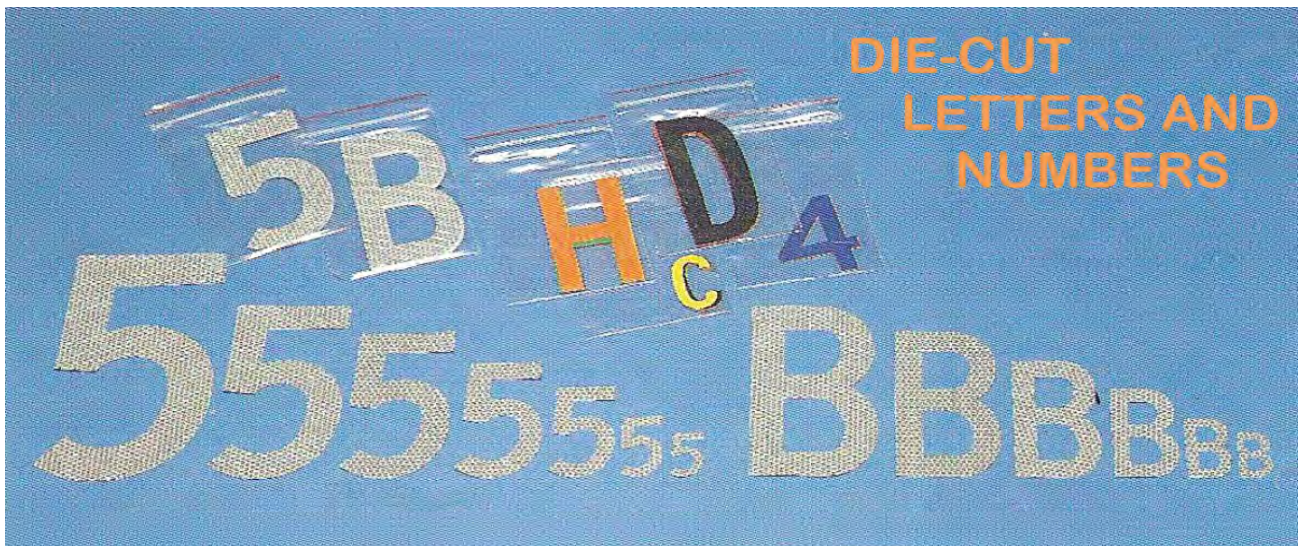

MULTI-PURPOSE MARKING MATERIALS



**PAINT FOR STRIPING
PAINT FOR SPRAYING
CHALK FOR DRY MARKING**



INTERSTATE SALES



INTERSTATE SALES

Warning Signs

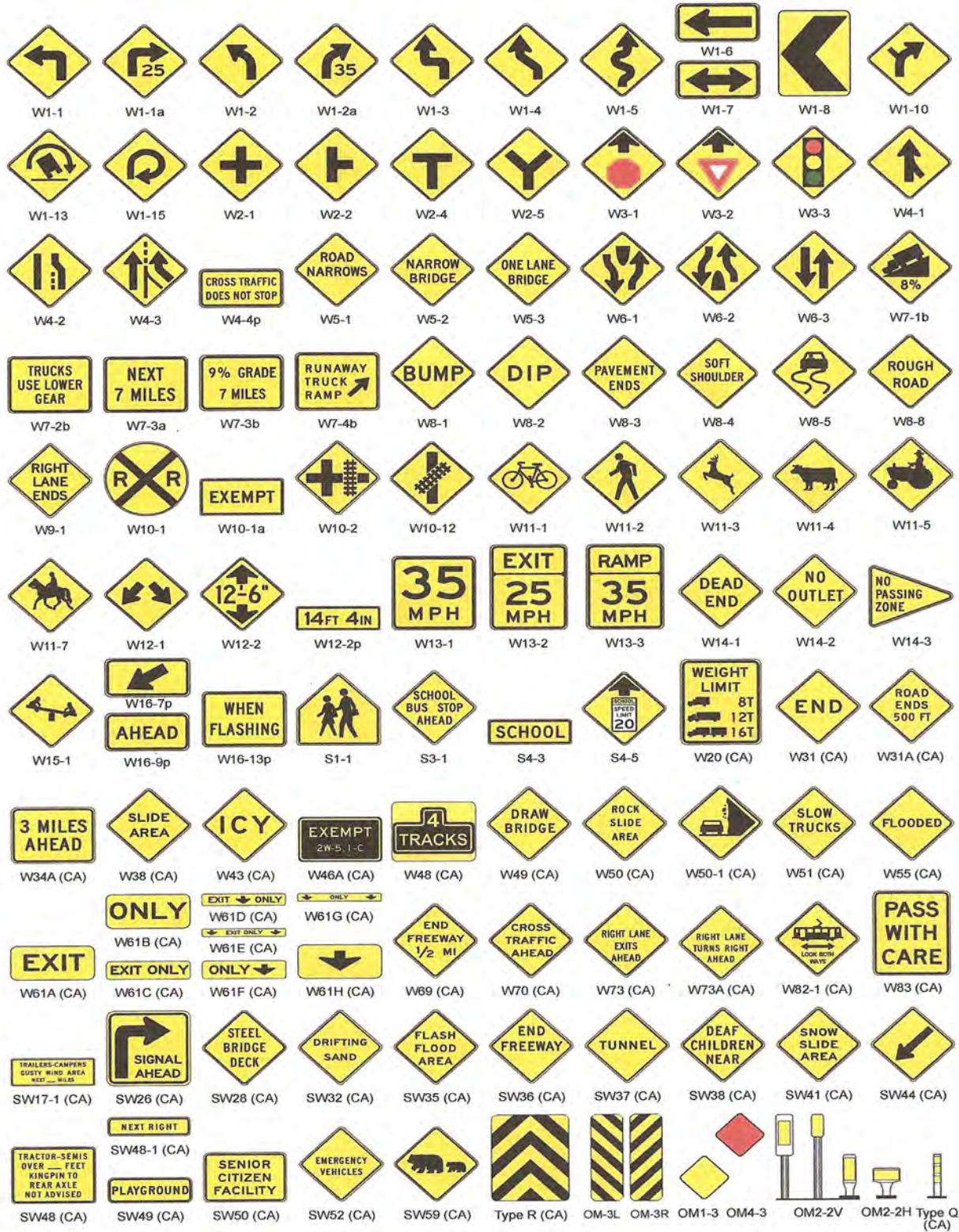

INTERSTATE SALES



INTERSTATE SALES

Construction Signs

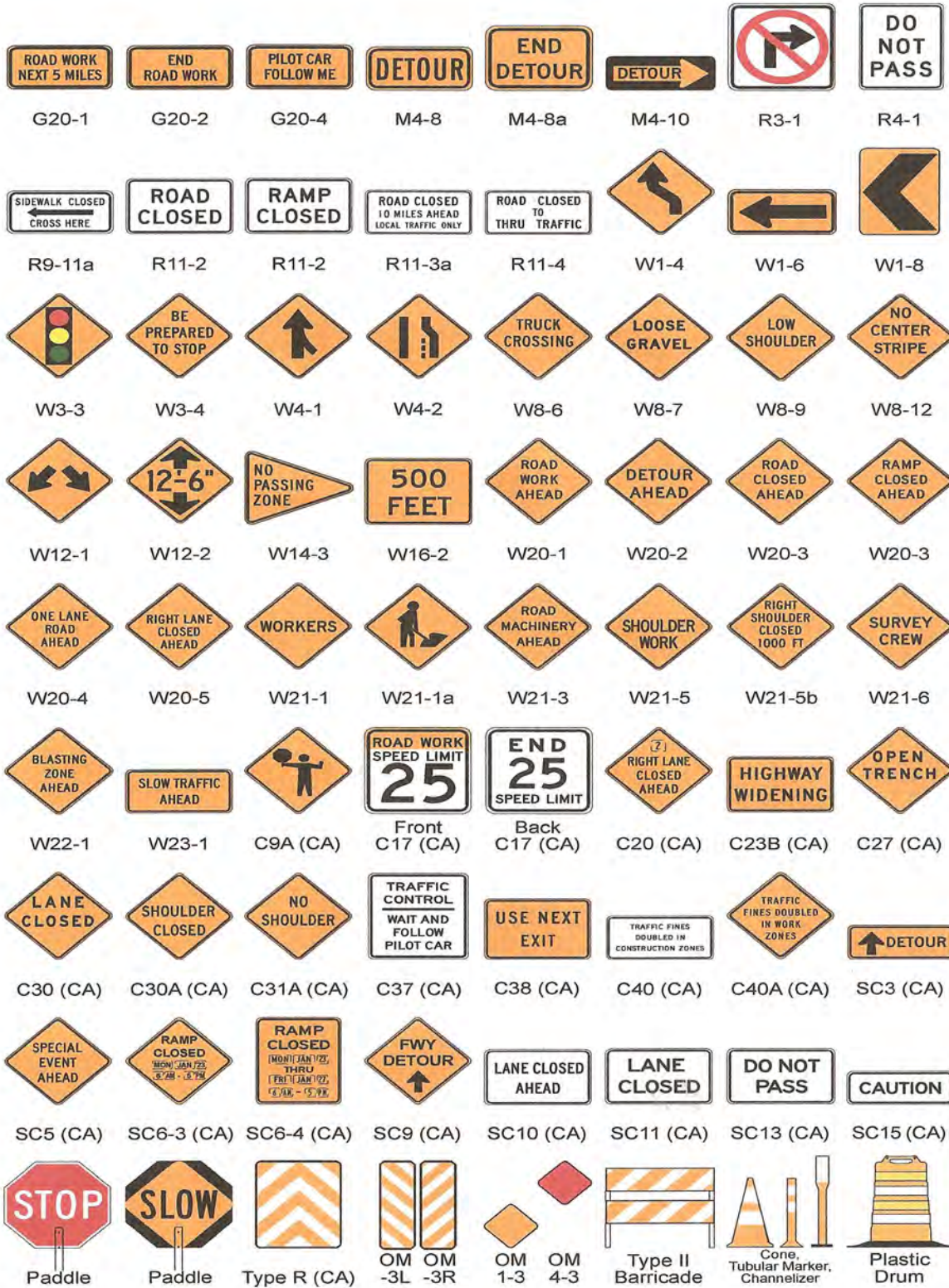

INTERSTATE SALES



LineLazer® 3900 Two Gun System



FieldLazer™ S100 Field Marking System



LineLazer® 3400 One Gun System



GrindLazer™ Scarifier Systems



LineDriver® Why walk when you can ride?



ThermoLazer® Thermo Stripping Systems



INTERSTATE SALES

Sales - Parts - Service



Guns



Hoses

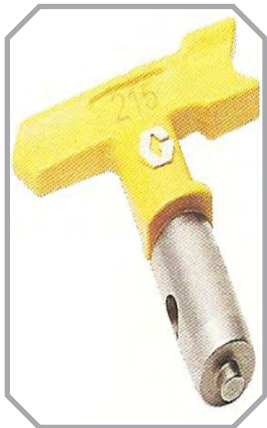

Tips



Wheels

PARTS We Got'em- When You Need'em



INTERSTATE SALES



Highway Guardrail

- metal beam guardrail
- thrie-beam barrier rail
- wood posts and blocks
- steel posts and blocks
- guardrail end treatments
- weed control mat
- glare screen

Bridge Components

- tubular handrail
- metal tube bridge railing
- steel truss bridges
- beam bridges
- bridge flooring
- aluminum bridge railing
- thrie-beam bridge railing
- cattle guards

Pavement Markings

- pavement markers
- pavement marker adhesive
- bituminous applicator
- traffic paint
- marking paint
- traffic beads
- thermoplastic
- striping tape
- chip-seal markers
- flametape

Construction Safety

- barricades
- flasher lights
- emergency warning lights
- traffic cones
- delineators
- flags and vests
- plastic safety fence
- plastic trash bags



INTERSTATES SALES

12600 LOCKSLEY LANE, STE. 200
AUBURN, CA 95602-2071

return service requested